

SPECIFICATION

Current Rating: 1 AMP
 Insulation Resistance: 1000MΩ Min.
 Contact Resistance: 20mΩ Max.
 Dielectric Voltage: 500V AC for one minute
 Operation Temperature: -40°C to +105°C

MATERIAL

Insulator: Hi-Temp. Thermoplastic, UL94V-0, Black
 Contact Pin: Copper Alloy

ORDER INFORMATION

5 P H 3 M S A 2 5 - 2 X X X X X N X U - A B C - 0 0

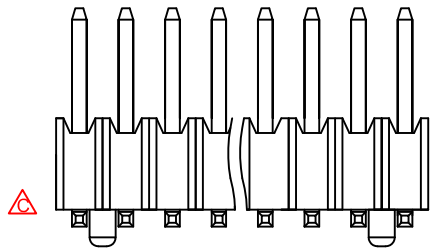
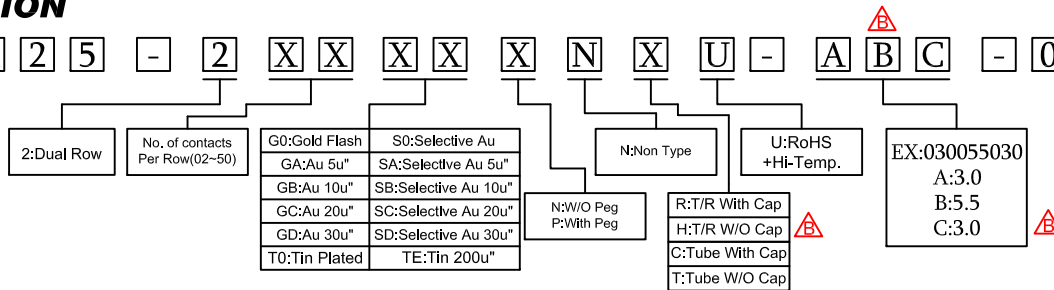

With Peg

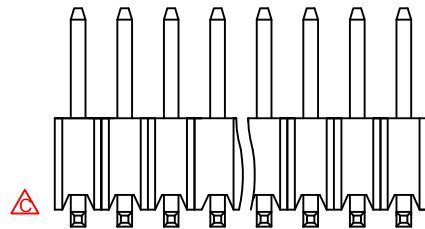

W/O Peg

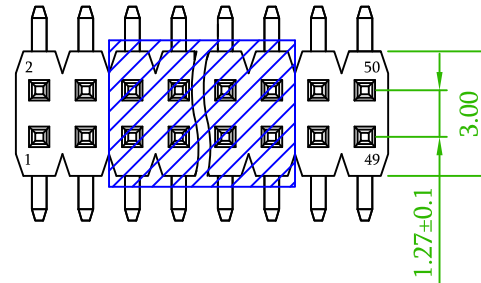

CAP	L	W	H (Ref.)
≧ 2 x 2 Pin	5.08	4.0	3.75

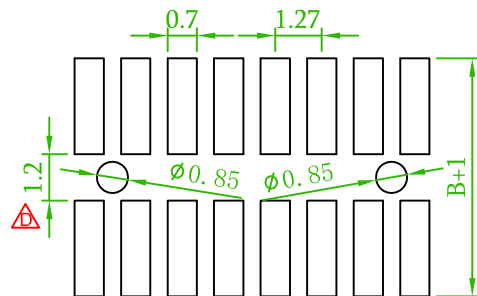

Recommended PCB Layout
 (PCB TOLERANCE ±0.1)

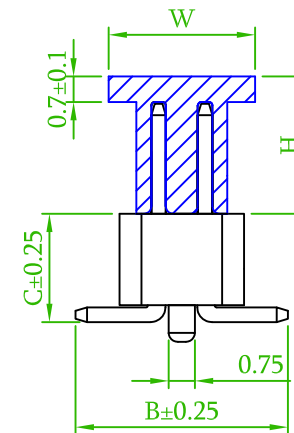
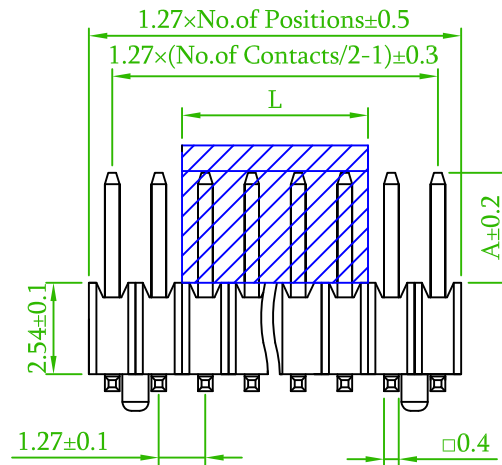

Old Part No. : PH3M25-2XX-U

△	ECN No.:171201, Revise the Cap.	Roy	2017/12/01
△	Modify P.C.B Layout	Gary	2017/03/20
△	Revise the drawing	Gary	2017/03/10
△	Modify order information	Gary	2017/02/06
REV.	ECN NO. OR DESCRIPTION	REVISED	DATE

Amtek Technology Co., Ltd.
 耀德精密有限公司
 TEL: 886-2-2260-6878
 FAX: 886-2-2260-8030

品名 TITLE	PIN HEADER 1.27mm				頁數 Page	1/1
品號 PART NO.	5PH3MSA25-2XXXXXXNXU-XXXXXXXXXX-00			圖號 DRAWN	Roy 2015/08/07	
圖號 DRAWING NO.	GN016-GA283		版本 REV.	E	核對 CHECKED	John 2015/08/07
客戶品號 CUSTOMER P/N			比例 SCALE	None	承認 APPROVED	John 2015/08/07
公差 TOLERANCE	.X ± 0.25	.XX ± 0.20	單位 UNIT	mm	THIRD ANGLE PROJECTION	