

Mechanical 

Standard: UL
 Rated Voltage: 600V
 Rated Current: 26A
 Withstanding voltage: AC 2000V for one min
 Contact Resinstate: 20MΩ
 Insulation Resinstate: 500MΩ/DC500V
 Wire range: 20-10AWG(UL) 1-6mm²(IEC)

Mechanical
 Temp. Range: -40°C ~ +105°C
 Torque: 0.5Nm(4.51b' in)
 Strip length: 7-8mm

Material

Housing: Nylon 66, UL94V-2
 Screws: M3, Steel, Zinc Plated
 Poles: 2P-12P



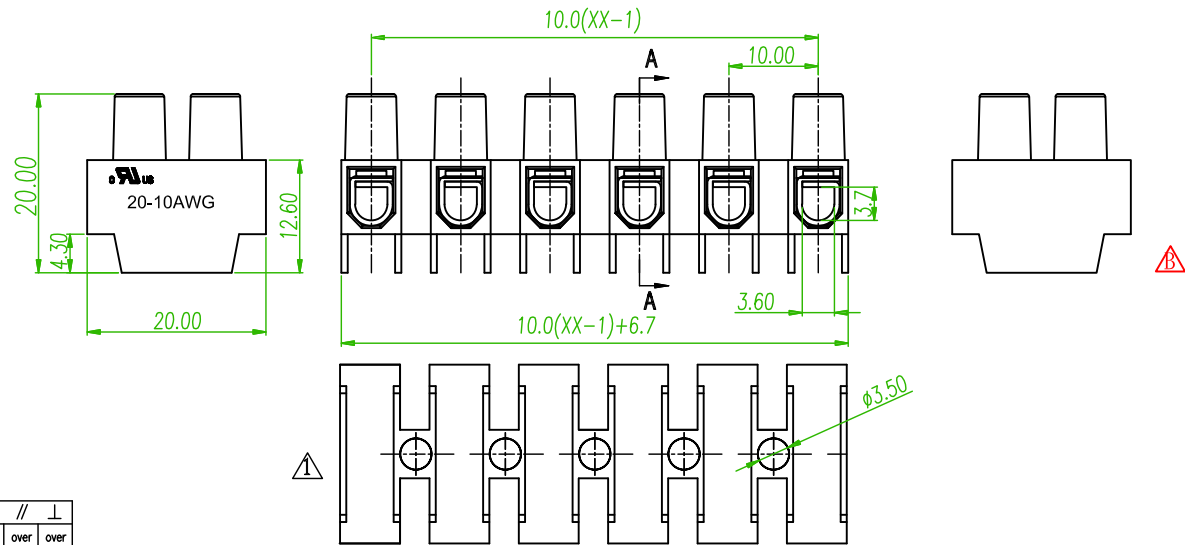
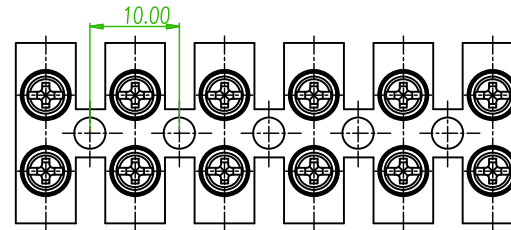
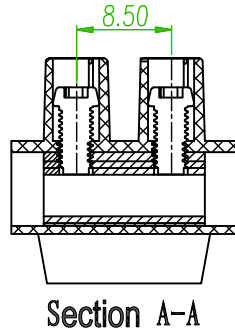
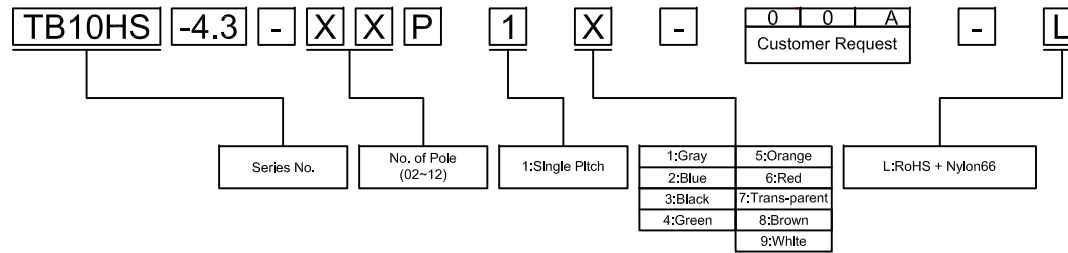

ORDER INFORMATION



TOLERANCES EXCEPT AS NOTED



		linear dimension (Tolerances Standard GB/T 14486-2008)											fillet	chamfer	short angle				≡	—	∥	⊥		
variable range	to	over 6 to 10	over 10 to 18	over 18 to 30	over 30 to 50	over 50 to 80	over 80 to 120	over 120 to 160	over 160 to 200	over 200 to 250	over 250 to	all	to 6	to 10	to 10	to 50	to 120	to 120	all	to 5	to 30	to 120	to 120	to 120
tolerance	±0.1	±0.14	±0.19	±0.25	±0.32	±0.43	±0.57	±0.72	±0.88	±1.05	±1.25	±0.2	±0.5	±1	1'	30'	20'	10'	0.5	0.025	0.06	0.12	0.4	

AREA	REV.	DESCRIPTION	DATE
	E	Revised the Drawing	2013/01/11 Jeff
	D	Revised the Tolerance table	2012/07/31 Jeff
	C	Revised the Drawing	2012/01/12 Joe
	B	Delete the VDE logo & Revised the Spec.	2011/12/19 Joe



Amtek Technology Co., Ltd.
 糧德精密有限公司
 TEL: 886-2-2268-8036
 FAX: 886-2-2268-8035

品名 TITLE	TB10HS-4.3-XXP-1X-00A-L				
品號 PART NO.	TB10HS-4.3-XXP-1X-00A-L			日期 DATE	2011/06/24
圖號 DRAWING NO.	版本 REV.	E	繪圖 DRAWN	Sinnys	
客戶品號 CUSTOMER P/N	比例 SCALE	FREE	核對 CHECKED	Anthony	
公差 TOLERANCE	.X ±0.20 .XX ±0.15	單位 UNIT	mm	核准 APPROVED	James